

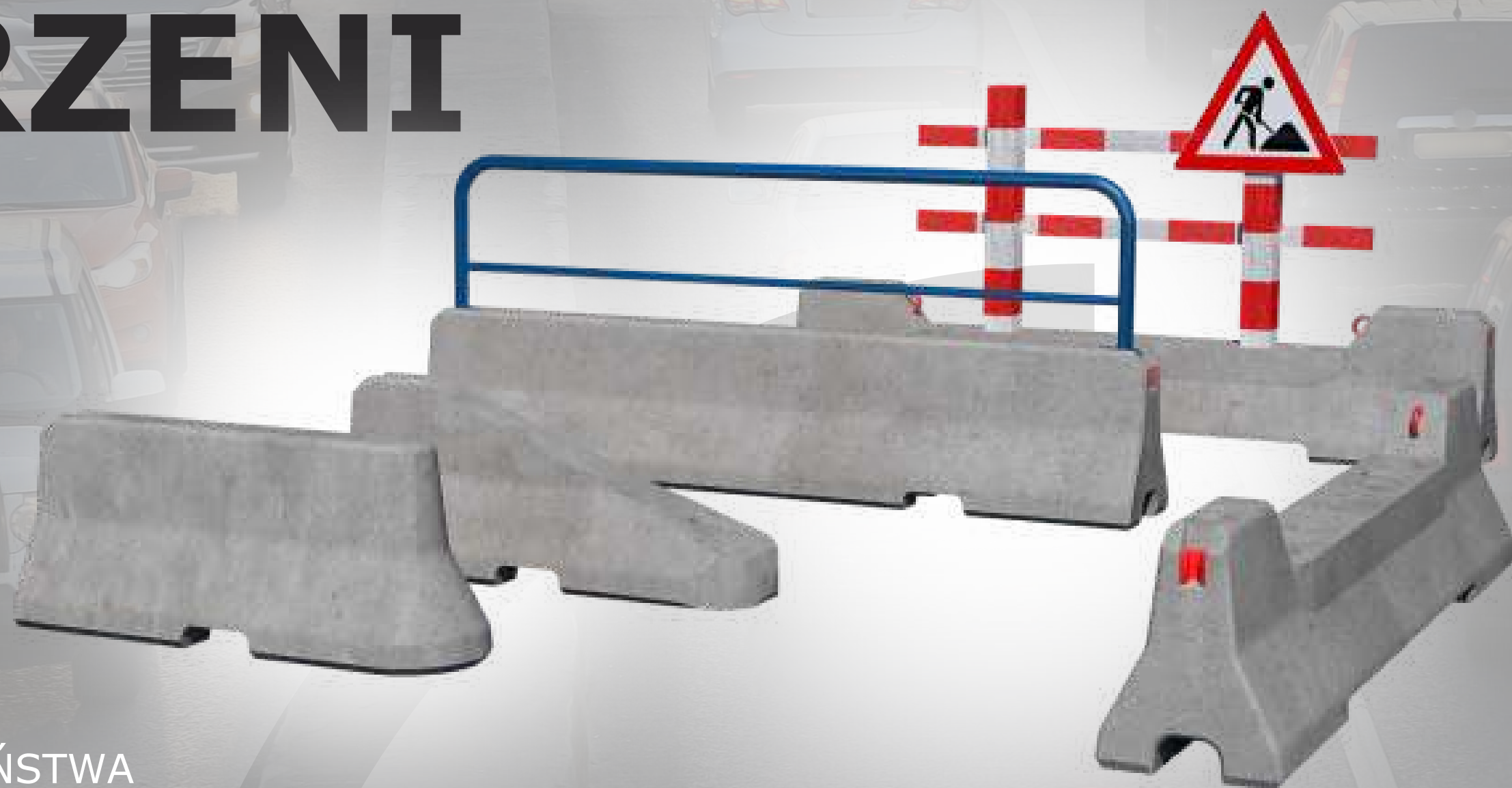

CITYBLOC®
SECURITY BARRIERS

NAJLEPSZE ROZWIĄZANIE DLA BEZPIECZEŃSTWA W PRZESTRZENI MIEJSKIEJ!



MODUŁOWE BARIERY BEZPIECZEŃSTWA

CZYM JEST CITYBLOC?

Są to **betonowe bariery bezpieczeństwa**, które chronią najbardziej narażonych na niebezpieczeństwo, czyli **pieszych i rowerzystów**.

Stosowane są w miejscach, gdzie istnieje ryzyko wystąpienia **kolizji** lub **wypadku drogowego**.

Stanowią one **fizyczną przeszkodę dla pojazdów**.

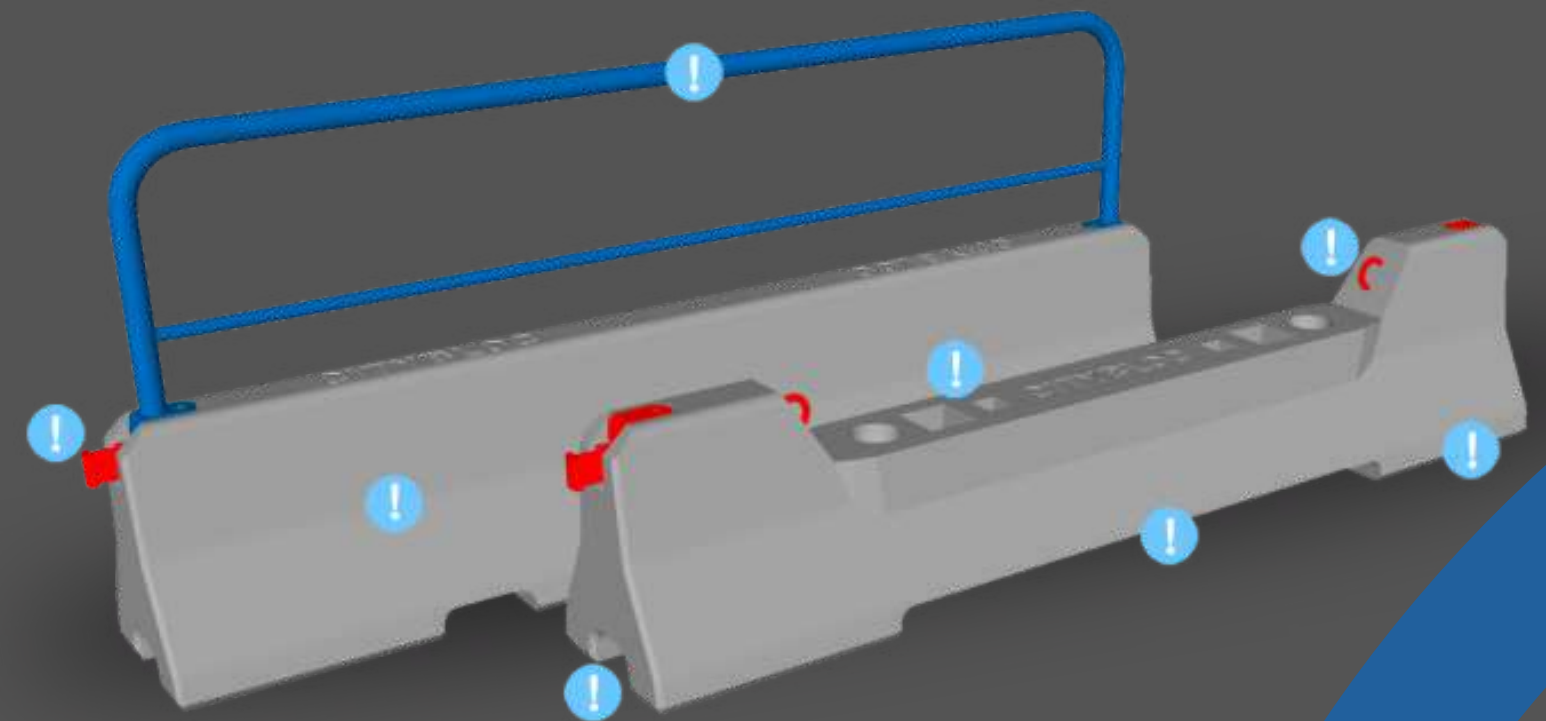

CO NAS WYRÓŻNIA?

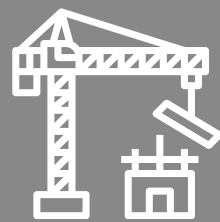

ZABEZPIECZENIE NA DUŻĄ I MAŁĄ SKALĘ

Łączenie poszczególnych elementów pozwala na tworzenie zabezpieczeń dla dużych i małych przedsięwzięć.

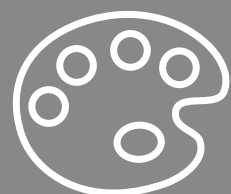

SZEROKA GAMA KOLORYSTYCZNA

Każdy z elementów bloków oraz dodatkowego wyposażenia można wybrać w dowolnym kolorze.



RÓŻNORODNOŚĆ ZASTOSOWAŃ

Bariery mają wiele zastosowań zarówno dla ruchu drogowego, jak i bezpieczeństwa pieszych.

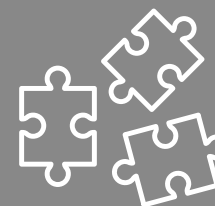

BUDOWA MODUŁOWA

Rozwiązania narożne do łączenia pod kątem 45° i 90°, poręcze, adaptory ogrodzeniowe i do znaków drogowych.



CITYBLOC®
SECURITY BARRIERS

GDZIE ZASTOSOWAĆ CITYBLOC?



**ROZGRANICZENIE
CHODNIKA OD JEZDNI**



**NA IMPREZACH
MASOWYCH**



**WZDŁUŻ ŚCIEŻEK
ROWEROWYCH**



CITYBLOC®
SECURITY BARRIERS

GDZIE ZASTOSOWAĆ CITYBLOC?



**PRZY PRZYSTANKACH
KOMUNIKACYJNYCH**



**WYZNACZANIE OBSZARÓW
PARKINGOWYCH**



**PRZY PRACACH
DROGOWYCH**



CITYBLOC®
SECURITY BARRIERS

GDZIE ZASTOSOWAĆ CITYBLOC?



NA LOTNISKACH



NA DWORCACH

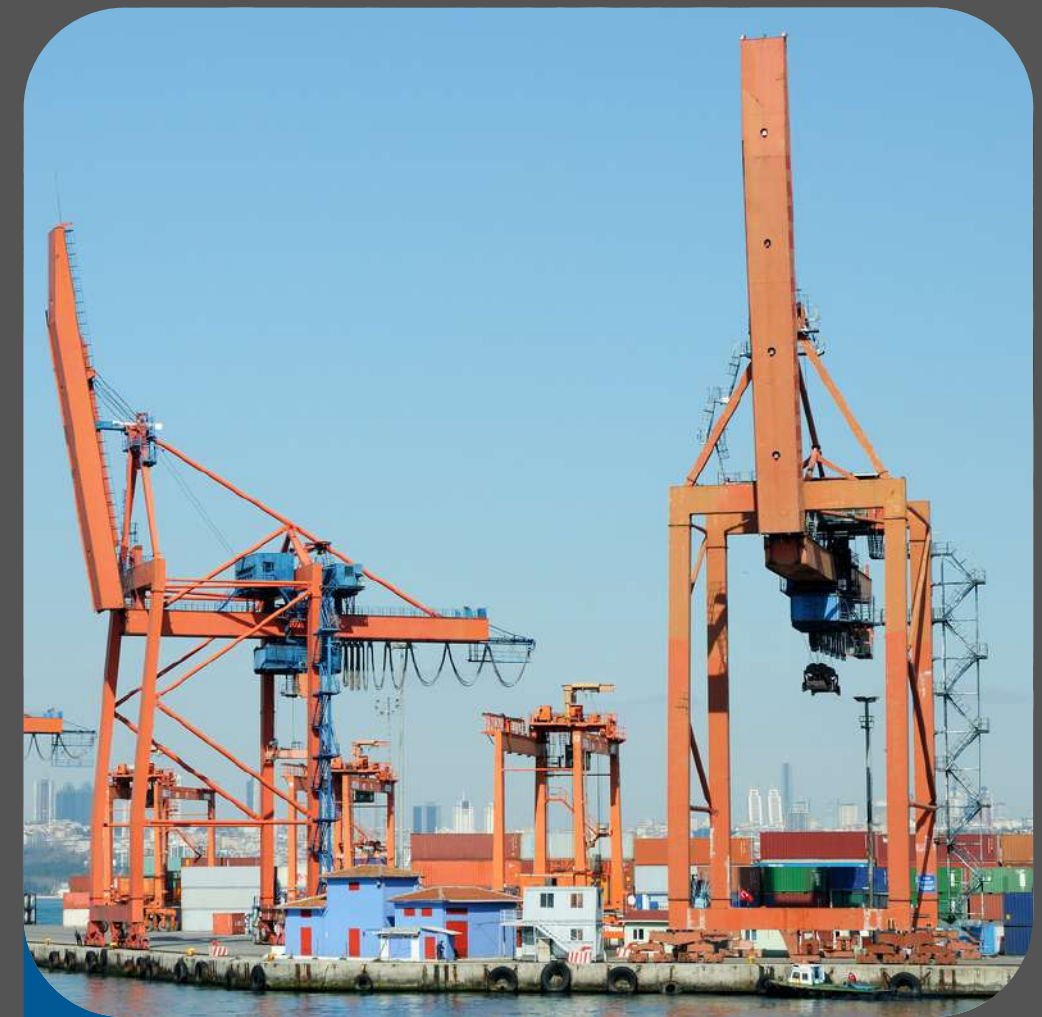

W PORTACH

GDZIE ZASTOSOWAĆ CITYBLOC?



**NA STACJACH
BENZYNOWYCH**



**W PRZESTRZENI
MIEJSKIEJ**



**PRZY CENTRACH
HANDLOWYCH**



DLACZEGO WARTO WYBRAĆ CITYBLOC?



DOSTAWA NA TERENIE EUROPY

Dostarczamy Citybloc na terenie
Polski i całej Europy.

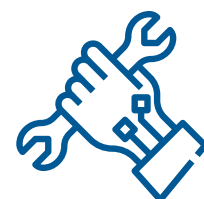

KOMPLEKSOWOŚĆ

Wybierając Citybloc, otrzymasz
kompleksową usługę (produkcja,
dostawa, montaż).



MOŻLIWOŚĆ WYNAJMU

Citybloc można zakupić lub wynająć
na określony czas.



**PRZYKŁADOWE
ELEMENTY
CITYBLOC**



Many railing solutions



45° and 90° corner elements



Many plug-in options

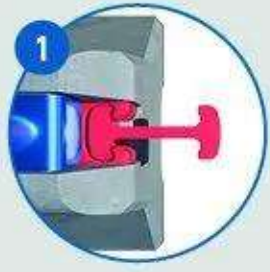

Screwless, patented element connection



Proven New-Jersey profile



Stability and safety



Drainage and cable ducting

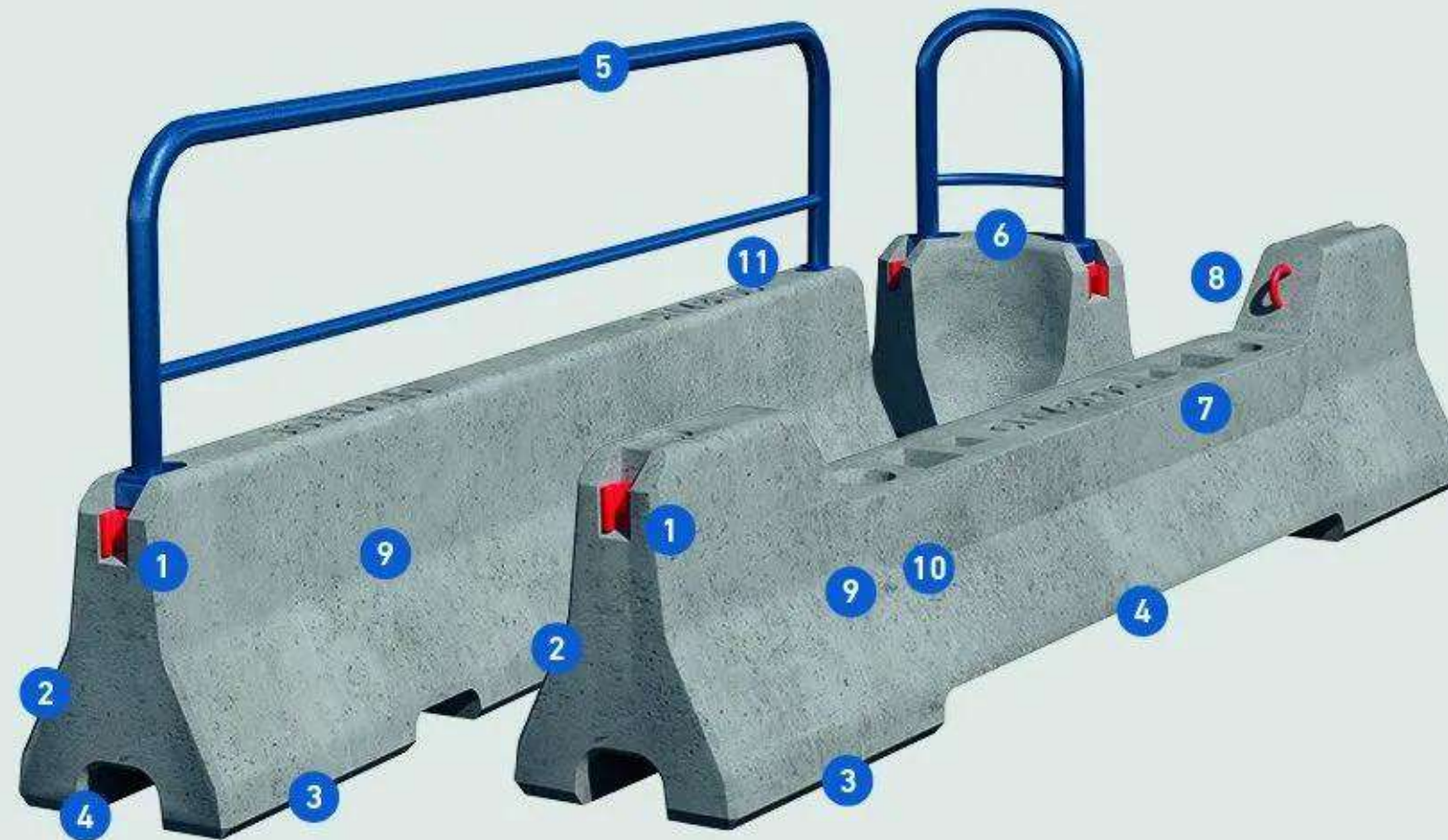

CITYBLOC® safety barriers

Integrated steel loops



Space-saving stacking

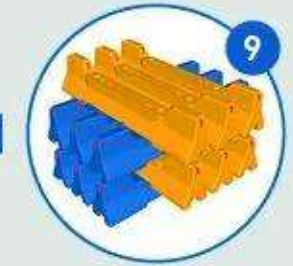

High-quality concrete

Smooth surface



EN 1317-2 tested CITYBLOC® elements



PROFIL NEW-JERSEY ZAPEWNIAJĄCY MAKSYMALNE BEZPIECZEŃSTWO PRZY ZDERZENIU

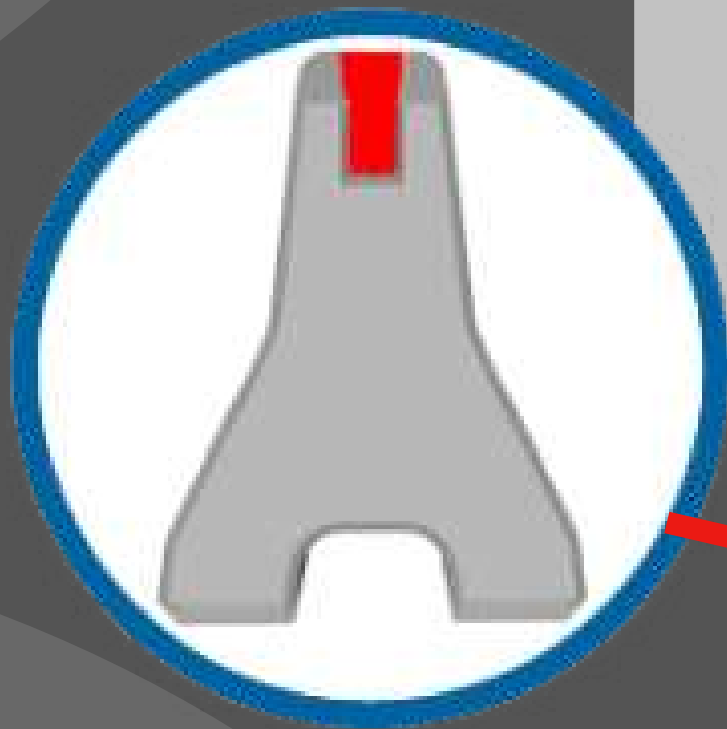

**PRZYKŁADOWE
ELEMENTY
CITYBLOC**

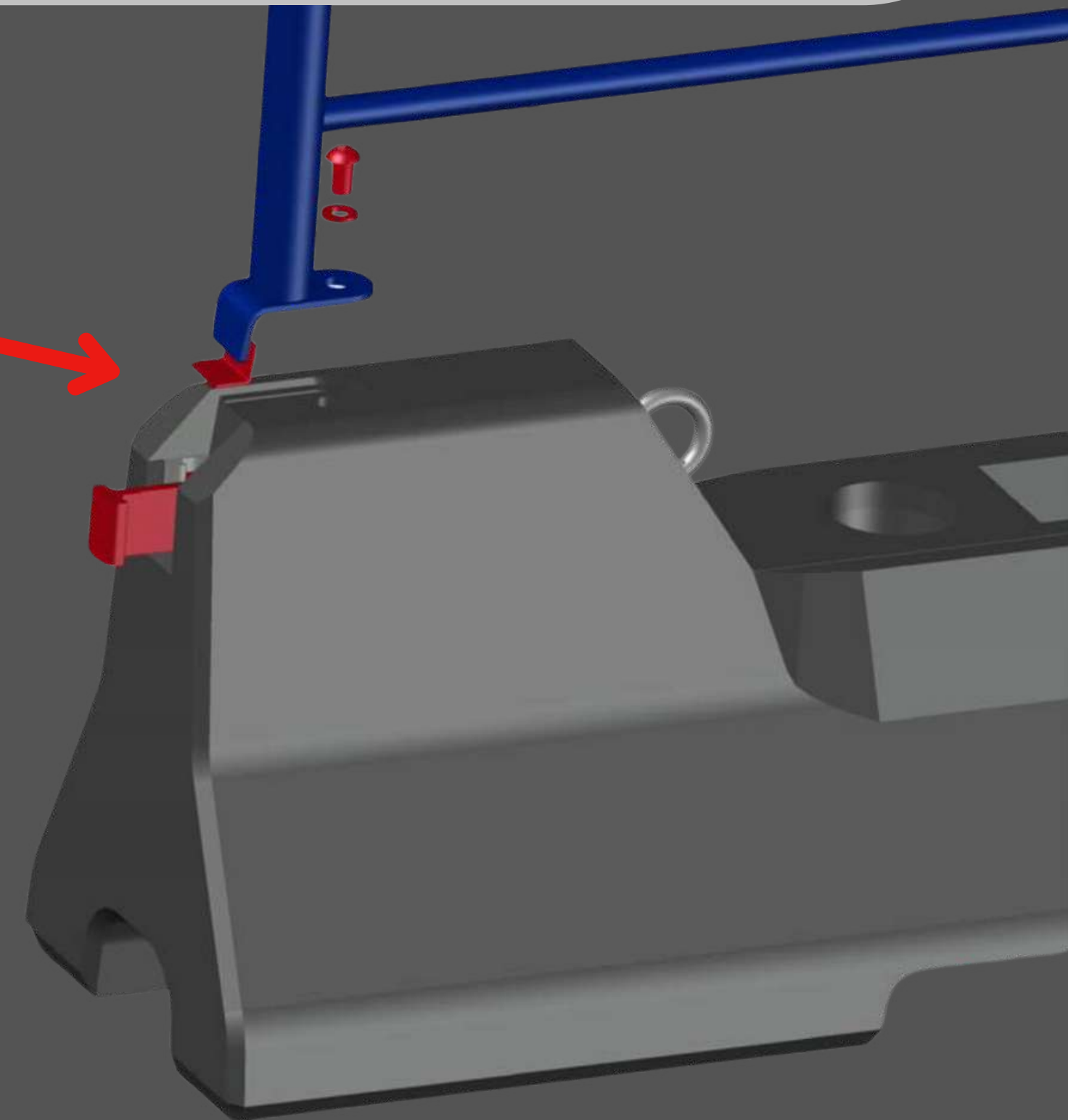

**PĘTLA ZE STALI
DO PODNOSZENIA
I PRZENOSZENIA**



**PRZYKŁADOWE
ELEMENTY
CITYBLOC**

ŁOŻYSKO ELASTOMEROWE ZAPEWNIAJĄCE STABILNOŚĆ I BEZPIECZYSTWO



**PRZYKŁADOWE
ELEMENTY
CITYBLOC**



SYSTEM SPRZĘGANIA - ŁĄCZNIĘ ELEMENTÓW BEZ UŻYCIA ŚRUB

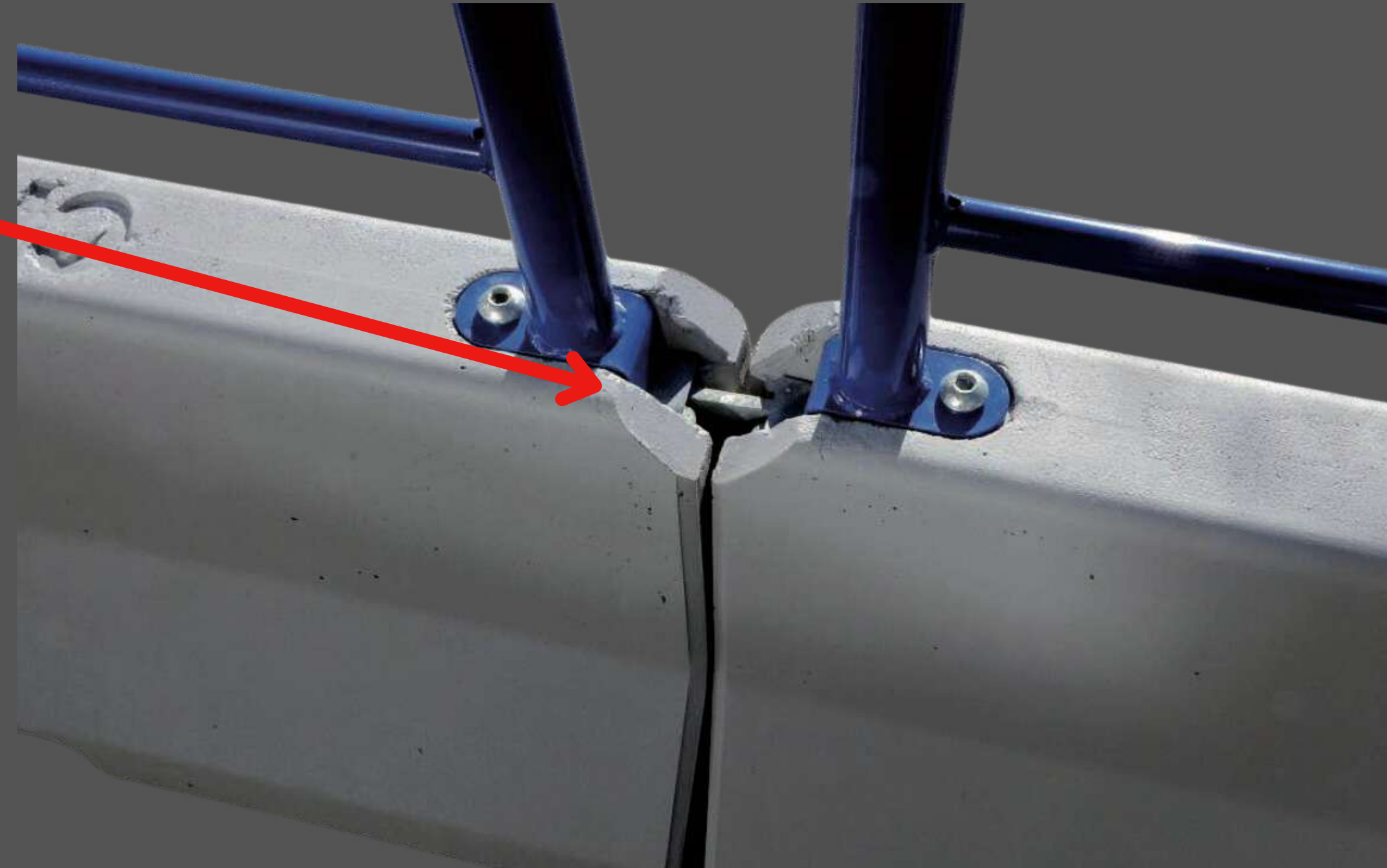
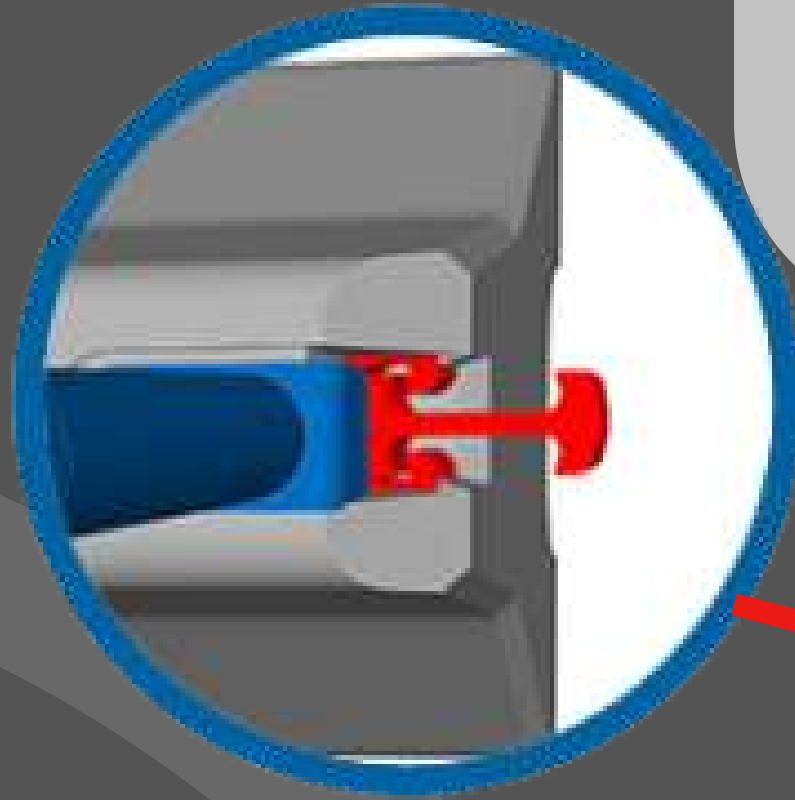

**PRZYKŁADOWE
ELEMENTY
CITYBLOC**

**ODPROWADZANIE WODY
I SCHOWANIE KABLI
W ESTETYCZNY SPOSÓB ZA
POMOCA PODŁUŻNYCH BRUZZ**

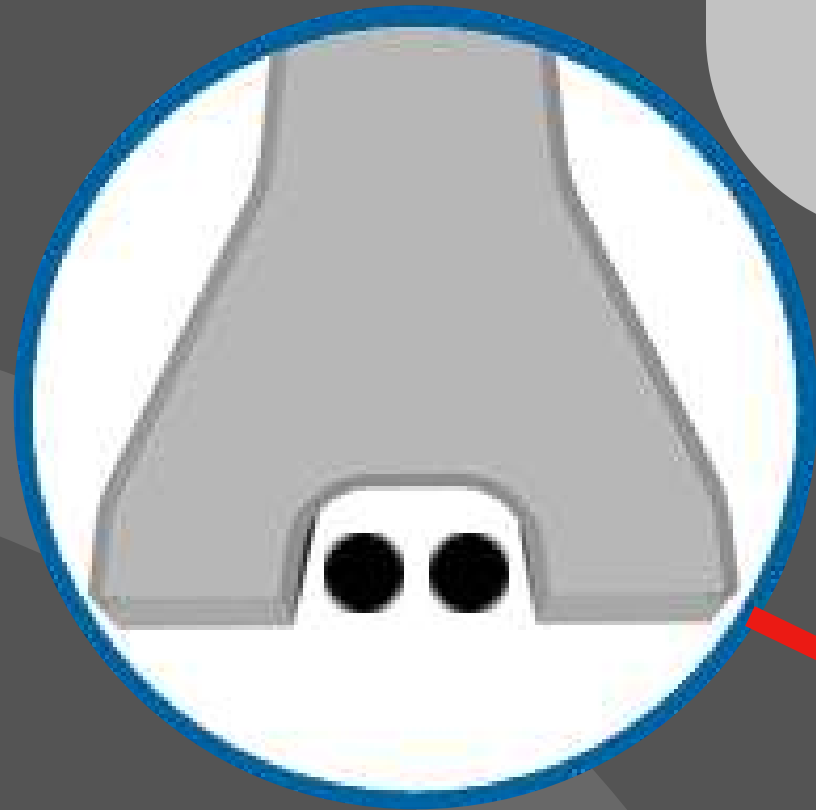

**PRZYKŁADOWE
ELEMENTY
CITYBLOC**



WIELOFUNKCYJNE ADAPTERY DO WYPOSAŻENIA DROGOWEGO

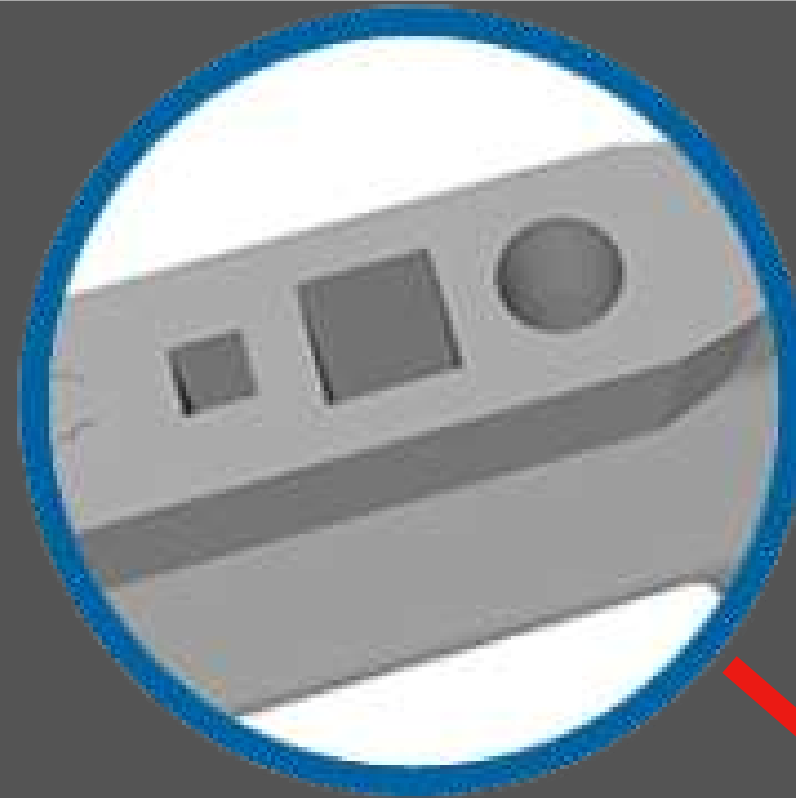

**PRZYKŁADOWE
ELEMENTY
CITYBLOC**

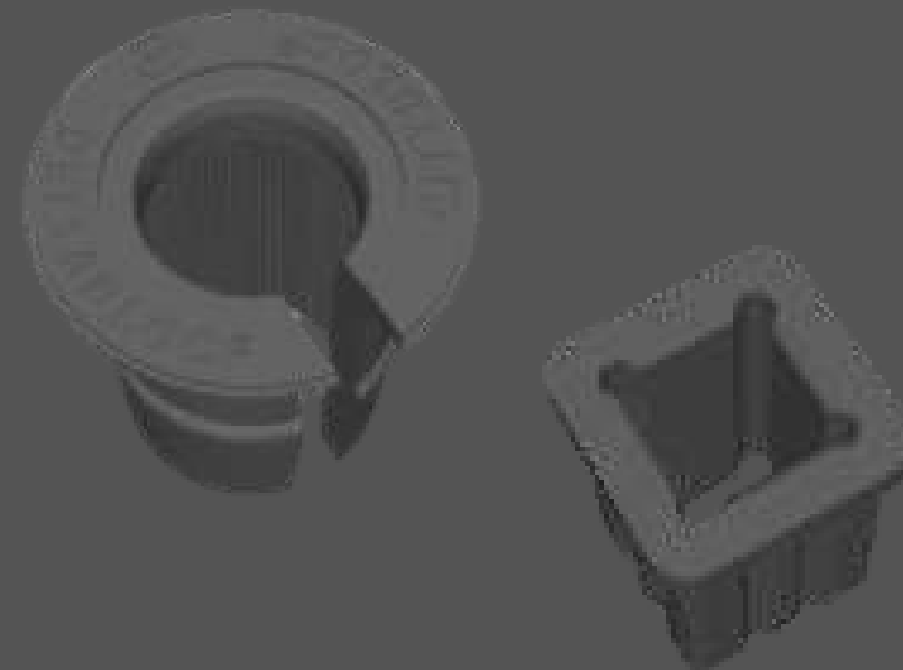

MIEJSCE NA REKLAMĘ



**PRZYKŁADOWE
ELEMENTY
CITYBLOC**

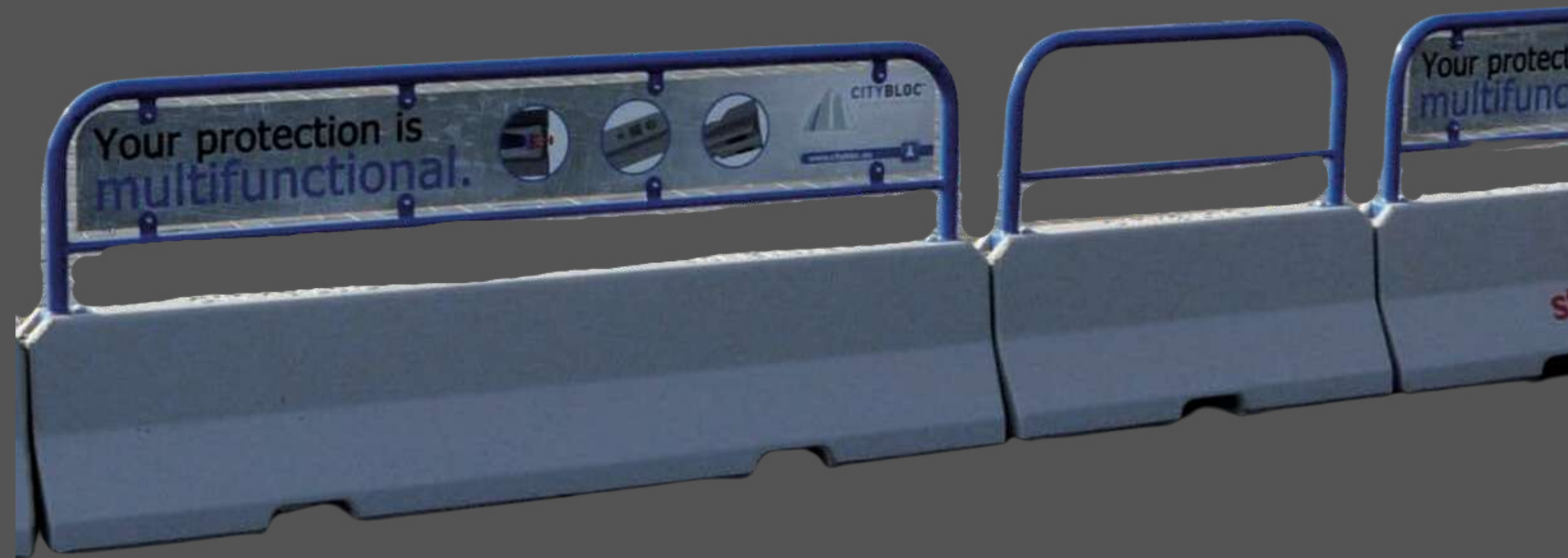

SYSTEM PIONOWEGO SKŁADOWANIA W OSZCZĘDZENIA PRZESTRZENI

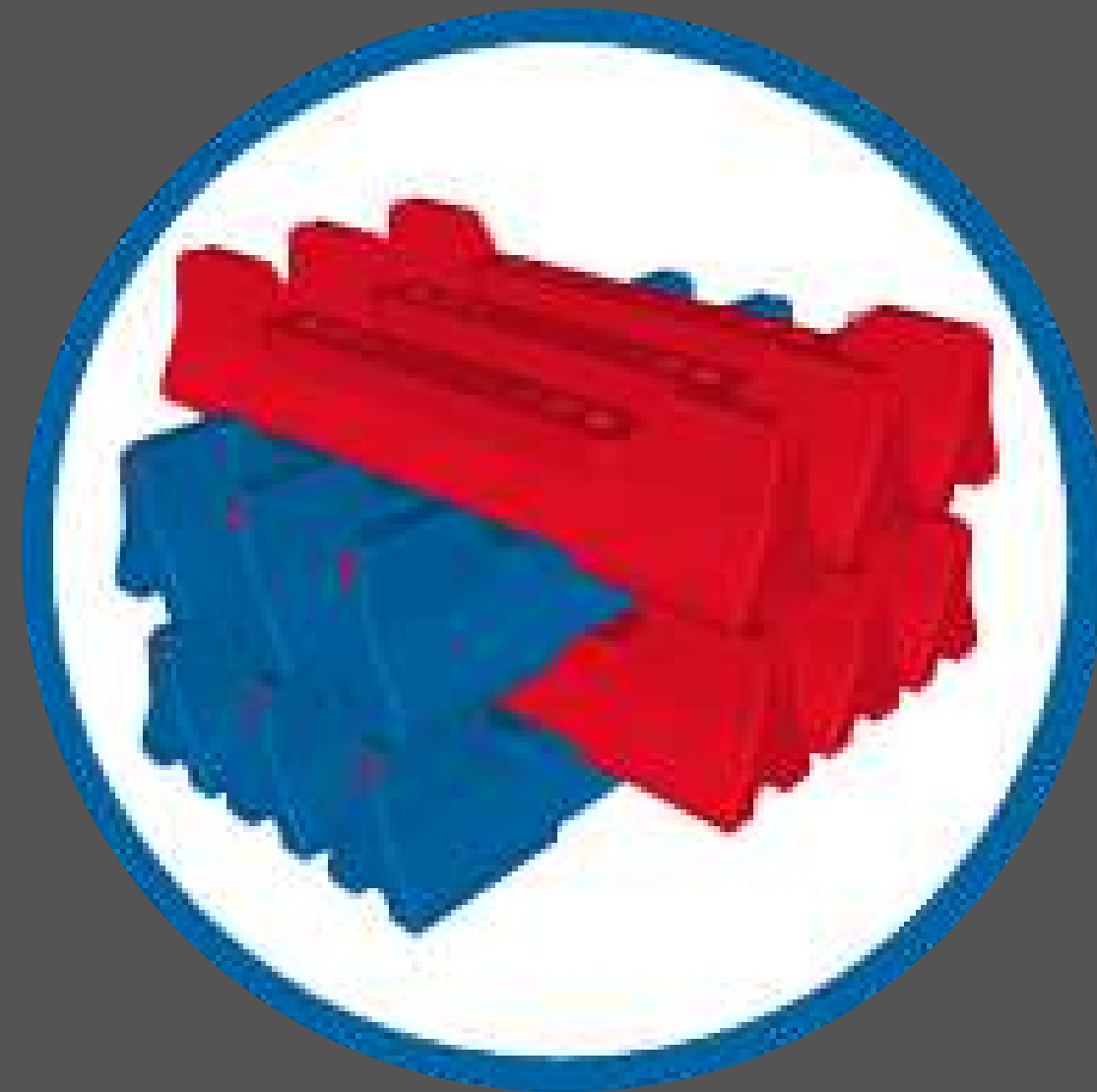

**PRZYKŁADOWE
ELEMENTY
CITYBLOC**



PRZYKŁADOWE REALIZACJE **CITYBLOC**



**PREMSTÄTTEN,
AUTOSTRADA A9,
AUSTRIA**



**ALTMANNSDORF,
AUSTRIA**



**UTRECHT,
DANIA**



**BRNO,
CZECHY**



**MÜRZZUSCHLAG,
AUSTRIA**

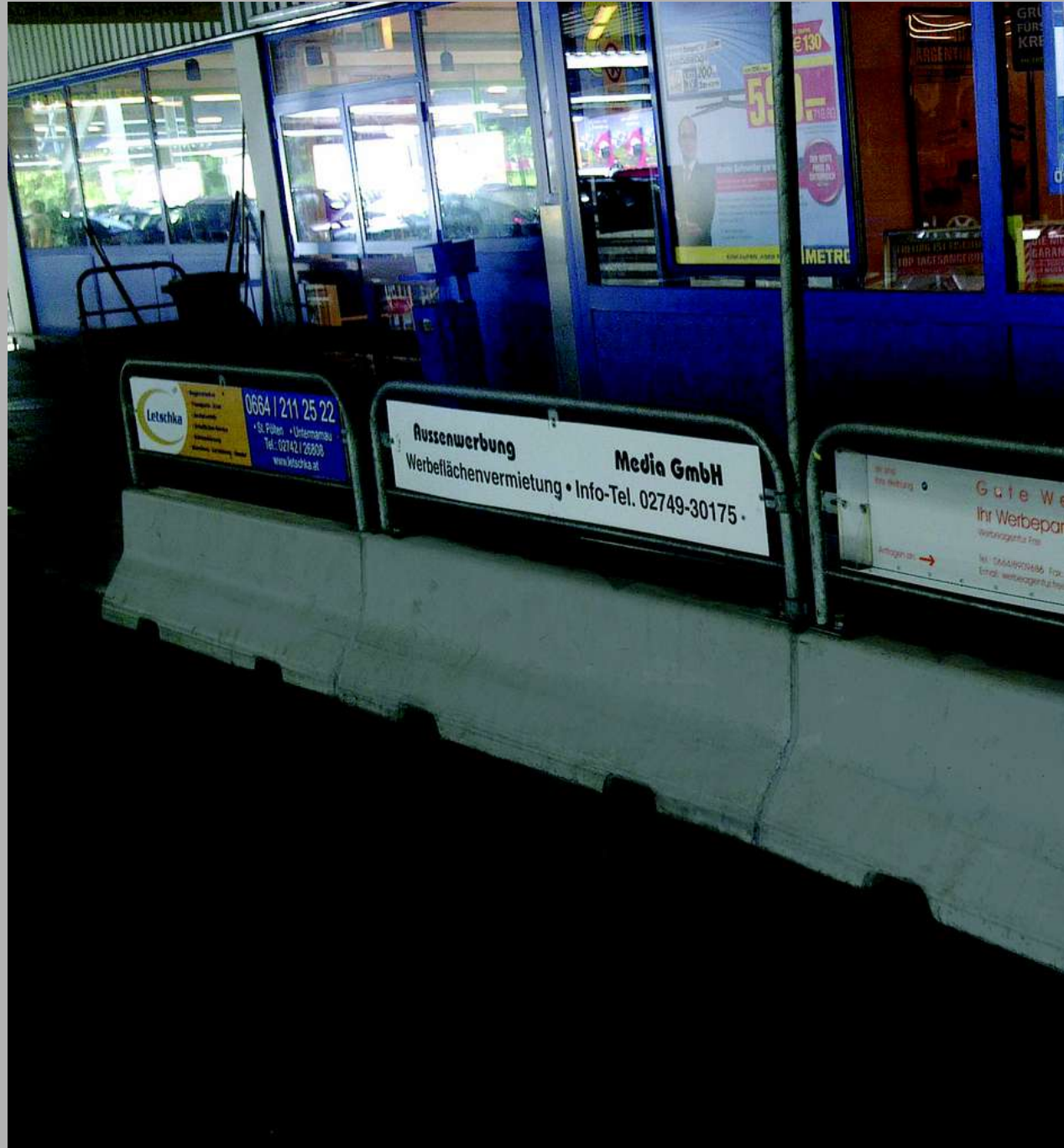

**CENTRUM HANDLOWE
ST. PÖLTEN,
AUSTRIA**



**ECKERNFÖRDE,
NIEMCY**



 **PERNITZ,
AUSTRIA**



 **SCHLESWIG-HOLSTEIN,
GERMANY**



**EASTERN TYROLE,
AUSTRIA**



**GRAZ,
AUSTRIA**

SKONTAKTUJ SIĘ Z NAMI

liadur®

Liadur Sp. z o. o.

 +48 513 513 017

 www.liadur.pl

 liadur@liadur.pl

 **BIURO:**
ul. Kościerzyńska 10,
51-430 Wrocław

